

## TERMO PS



## PICTURES



## OPENING INSTRUCTIONS

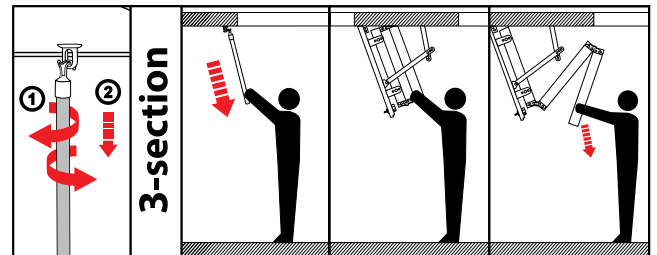

## TECHNICAL DRAWINGS AND DIMENSIONS

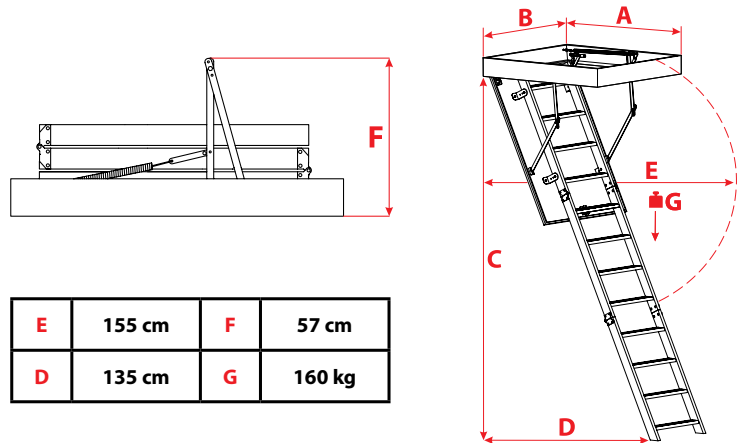

E	155 cm	F	57 cm
D	135 cm	G	160 kg



MAX. LOADING

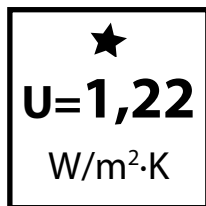

BASIC

26 mm

INSULATED HATCH THICKNESS

WHITE

HATCH COLOUR FROM BOTH SIDES

3-SECTION  
WOODEN LADDER

135 mm

HEIGHT OF WOODEN BOX

280 cm

MAXIMUM CEILING HEIGHT

### ADDITIONAL ACCESSORIES



HANDRAIL



MASKING  
BATTEN



MOUNTING  
SYSTEM

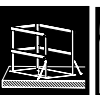

GUARD RAIL



PROTECTIVE  
FEET

### BOX DIMENSIONS [cm]

OUTER BOX DIMENSIONS, MOUNTING HOLE 2 cm LARGER

110x55	120x55	130x55	140x55
110x60	120x60	130x60	140x60
110x70	120x70	130x70	140x70

### NON-STANDARD BOX DIMENSIONS [cm]

DIMENSIONS GIVEN BELOW ARE APPROXIMATE DIMENSIONS ONLY

MIN-MAX LENGTH	110 - 140
MIN-MAX WIDTH	54 - 85
MINIMAL DIMENSION	110 x 54

## THERMO-STOP SYSTEM

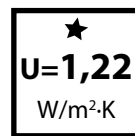

BASIC

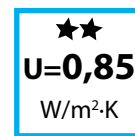

GOOD



VERY GOOD

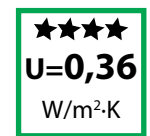

ENERGY SAVING

## OMAN STANDARD



3 YEAR GUARANTEE

EN 14975

COMPLIANCE  
WITH THE  
STANDARD